

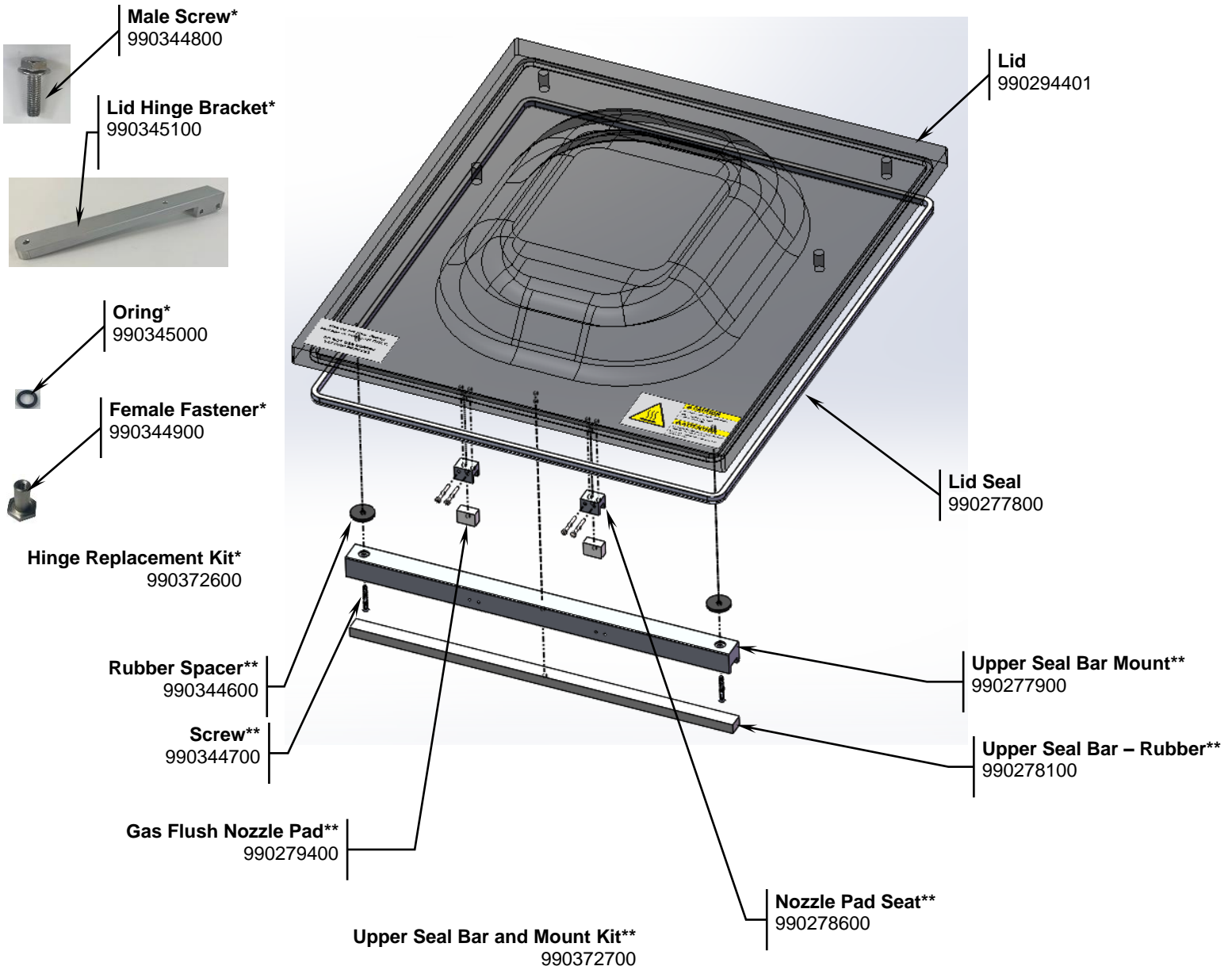

## Parts and Accessories Diagram

**PROPRIETARY RIGHTS NOTICE** This document and all information contained within it is the property of Hamilton Beach Brands, Inc. (HBB). It is confidential and proprietary and has been provided to you for a limited purpose. It must be returned or destroyed upon request. Disclosure, reproduction or use of this document and any information contained within it, in full or in part, for any purpose is forbidden without the prior written consent of HBB. No photographs may be taken of any article fabricated or assembled from this document without the prior written consent of HBB.



 <p>Hamilton Beach 4421 Waterfront Drive Glen Allen, VA 23060</p>	Revision Description:	Change adhesive tape part to 990278500					
	Request Number:	DOC12572	Revision Date:	01/24/2023	Approved by:	DOC12572	
	Issue Code(s):		Page:	1 of 4	Document #:	540098901	Rev:

## Parts and Accessories Diagram

**PROPRIETARY RIGHTS NOTICE** This document and all information contained within it is the property of Hamilton Beach Brands, Inc. (HBB). It is confidential and proprietary and has been provided to you for a limited purpose. It must be returned or destroyed upon request. Disclosure, reproduction or use of this document and any information contained within it, in full or in part, for any purpose is forbidden without the prior written consent of HBB. No photographs may be taken of any article fabricated or assembled from this document without the prior written consent of HBB.

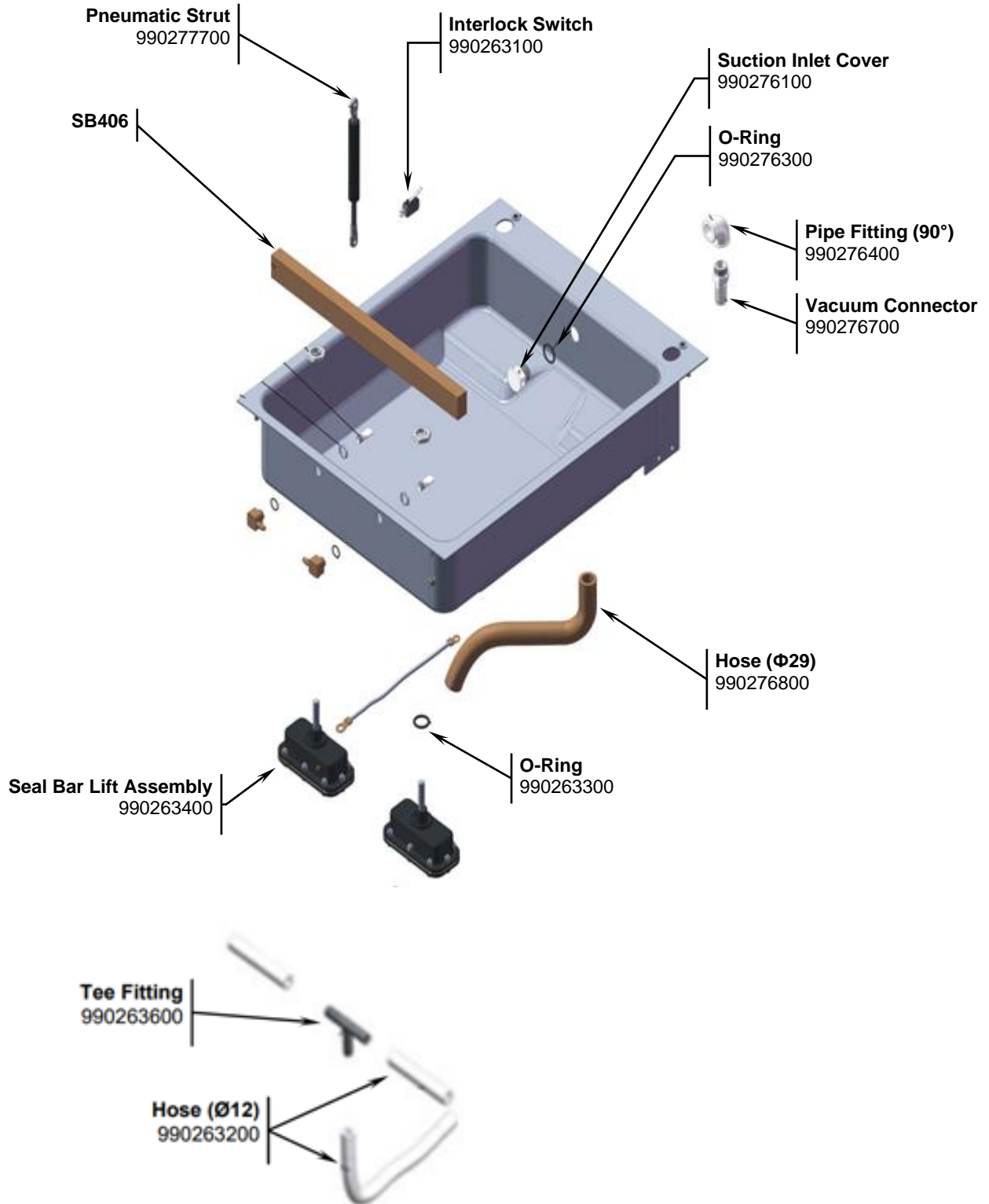

 <p>Hamilton Beach 4421 Waterfront Drive Glen Allen, VA 23060</p>	Revision Description:	Change adhesive tape part to 990278500					
	Request Number:	DOC12572	Revision Date:	01/24/2023	Approved by:	DOC12572	
	Issue Code(s):		Page:	2 of 4	Document #:	540098901	Rev:

## Parts and Accessories Diagram

**PROPRIETARY RIGHTS NOTICE** This document and all information contained within it is the property of Hamilton Beach Brands, Inc. (HBB). It is confidential and proprietary and has been provided to you for a limited purpose. It must be returned or destroyed upon request. Disclosure, reproduction or use of this document and any information contained within it, in full or in part, for any purpose is forbidden without the prior written consent of HBB. No photographs may be taken of any article fabricated or assembled from this document without the prior written consent of HBB.

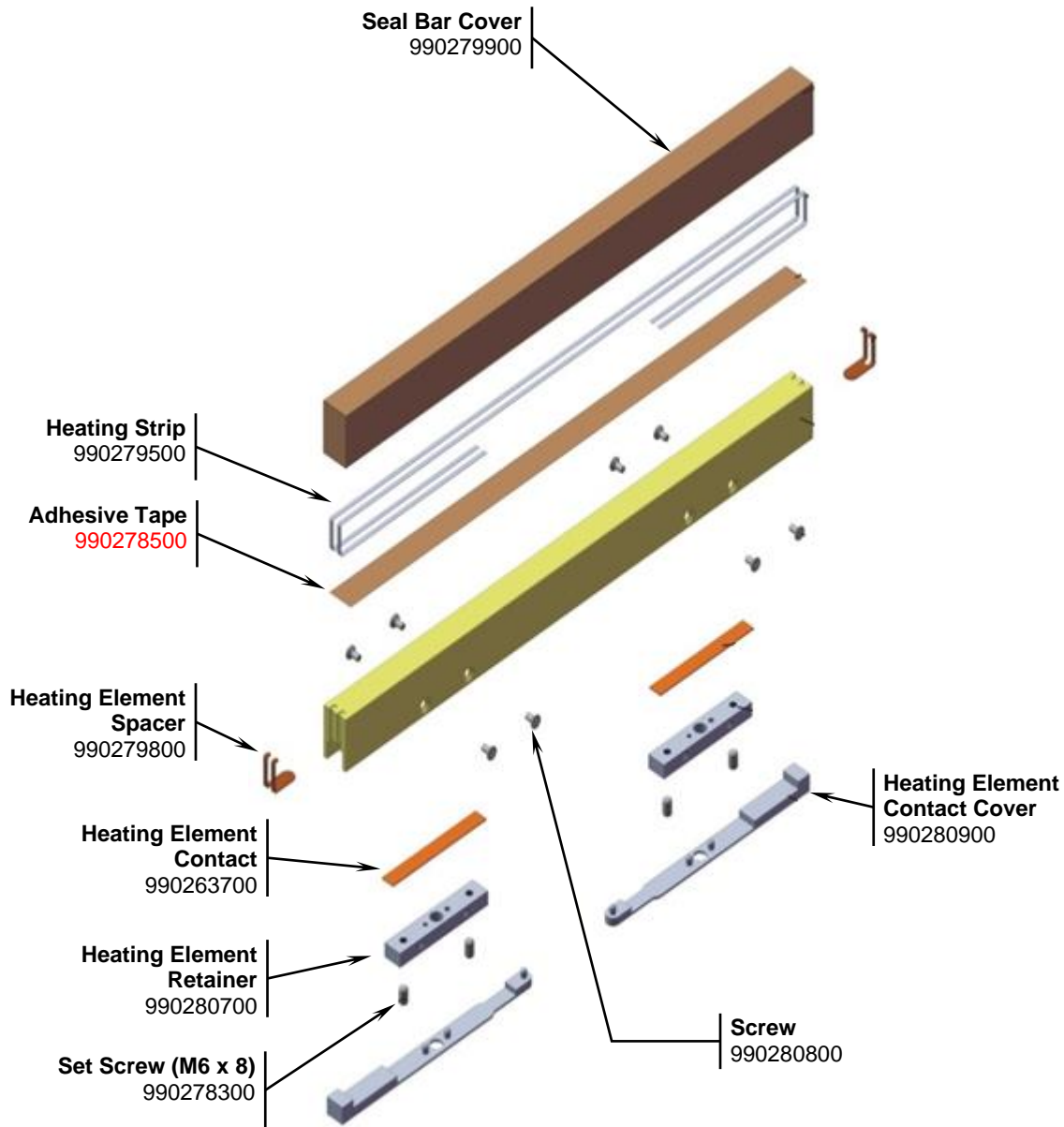

 <p>Hamilton Beach 4421 Waterfront Drive Glen Allen, VA 23060</p>	Revision Description: Change adhesive tape part to 990278500		Revision Date: 01/24/2023		Approved by: DOC12572	
	Request Number: DOC12572	Page: 3 of 4		Document #: 540098901	Rev: F	
	Issue Code(s):					

## Parts and Accessories Diagram

**PROPRIETARY RIGHTS NOTICE** This document and all information contained within it is the property of Hamilton Beach Brands, Inc. (HBB). It is confidential and proprietary and has been provided to you for a limited purpose. It must be returned or destroyed upon request. Disclosure, reproduction or use of this document and any information contained within it, in full or in part, for any purpose is forbidden without the prior written consent of HBB. No photographs may be taken of any article fabricated or assembled from this document without the prior written consent of HBB.

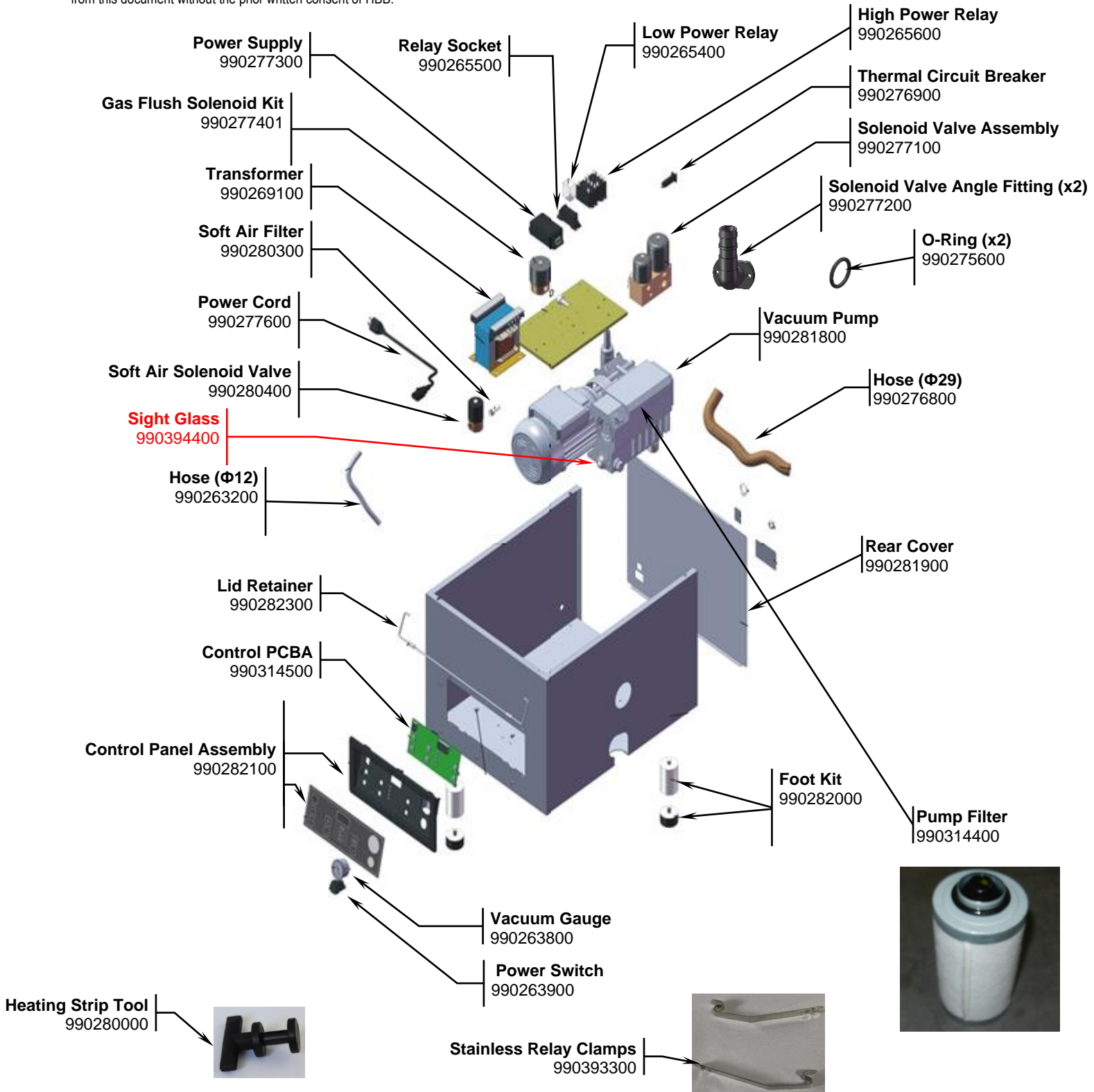

<p>Hamilton Beach 4421 Waterfront Drive Glen Allen, VA 23060</p>	Revision Description: Change adhesive tape part to 990278500					
	Request Number:	DOC12572	Revision Date:	01/24/2023	Approved by:	DOC12572
	Issue Code(s):		Page:	4 of 4	Document #:	540098901
					Rev:	F