

Parts & Accessories Diagram

Model HMD900

PROPRIETARY RIGHTS NOTICE This document and all information contained within it is the property of Hamilton Beach Brands, Inc. (HBB). It is confidential and proprietary and has been provided to you for a limited purpose. It must be returned or destroyed upon request. Disclosure, reproduction or use of this document and any information contained within it, in full or in part, for any purpose is forbidden without the prior written consent of HBB. No photographs may be taken of any article fabricated or assembled from this document without the prior written consent of HBB.

Not Shown:

Bumper – 35109490000

Motor Brush Kit - 990097500

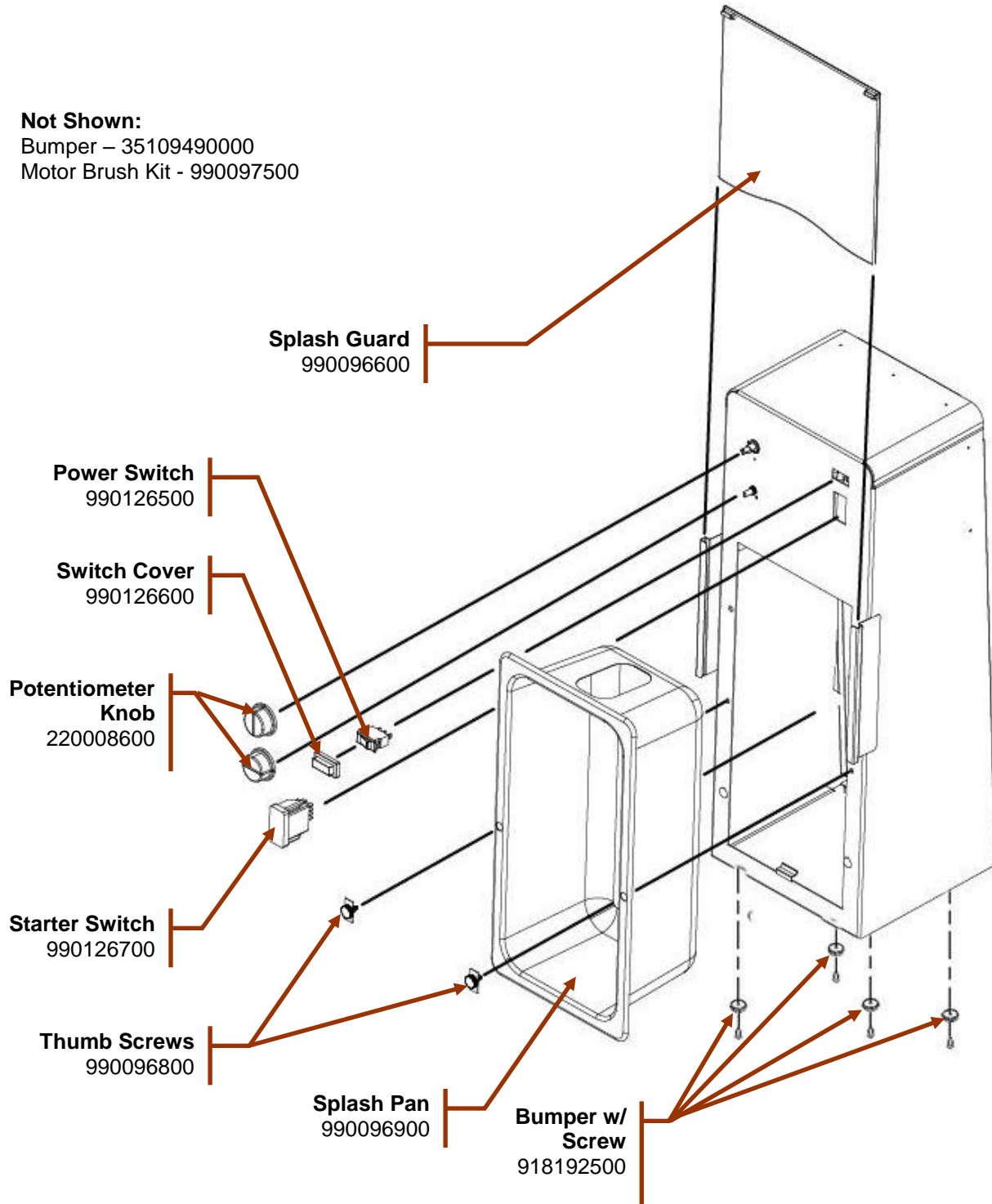

 4421 Waterfront Drive Glen Allen, VA 23060	Revision Description:	Production Release					
	Request Number:	DOC3111	Revision Date:	10/9/13	Approved by:	DOC3111	
	Issue Code(s):	CS, SP	Page:	1 of 3	Document #:	540018000	Rev:

Parts & Accessories Diagram

Model HMD900

PROPRIETARY RIGHTS NOTICE This document and all information contained within it is the property of Hamilton Beach Brands, Inc. (HBB). It is confidential and proprietary and has been provided to you for a limited purpose. It must be returned or destroyed upon request. Disclosure, reproduction or use of this document and any information contained within it, in full or in part, for any purpose is forbidden without the prior written consent of HBB. No photographs may be taken of any article fabricated or assembled from this document without the prior written consent of HBB.

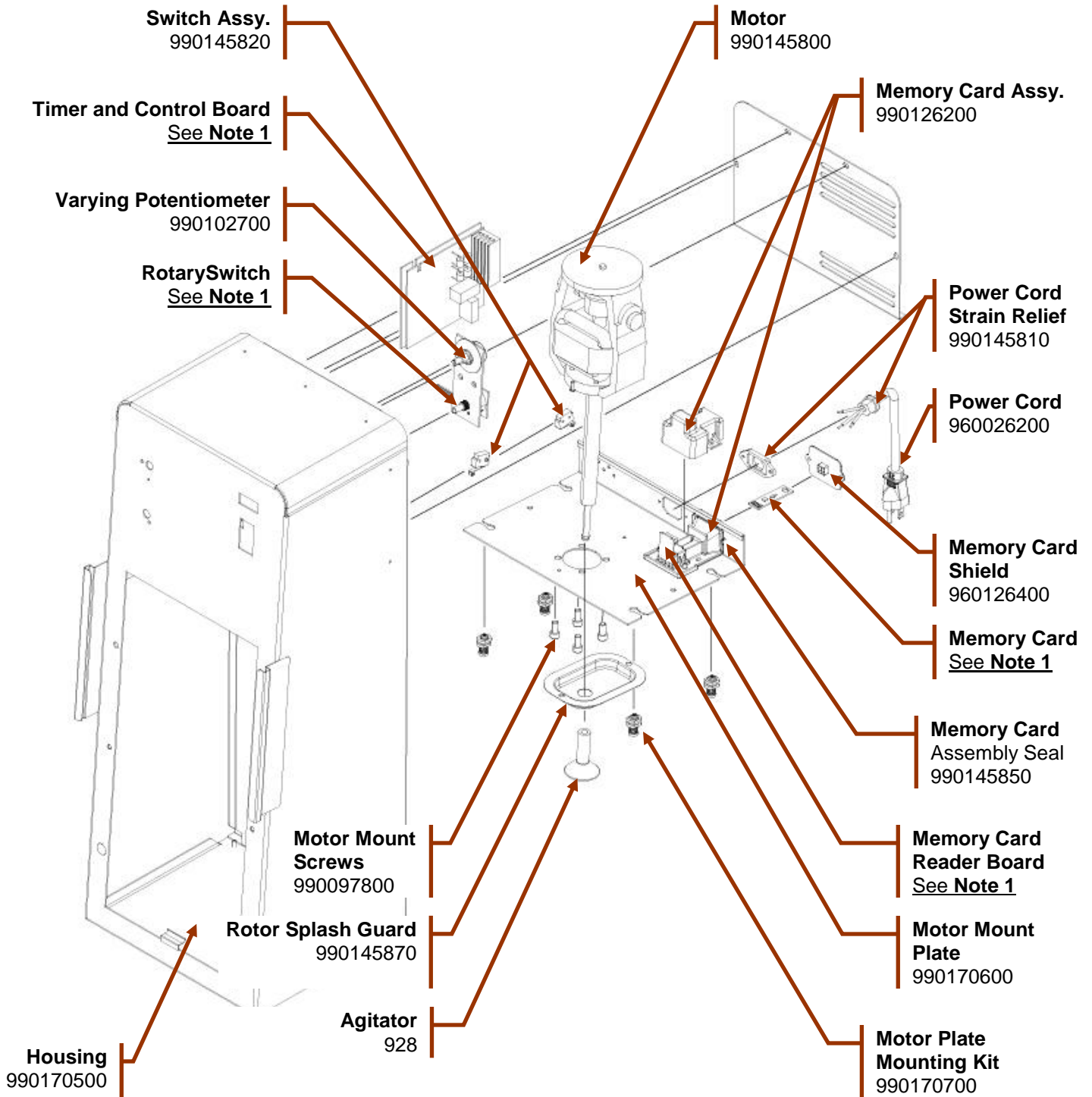

Note 1: Part of Control Assembly Kit #990150300 (Same as Main Power #50-1263A-35001)

 <p>Hamilton Beach 4421 Waterfront Drive Glen Allen, VA 23060</p>	Revision Description:		Production Release				
	Request Number:	DOC3111	Revision Date:	10/9/13	Approved by:	DOC3111	
	Issue Code(s):	CS, SP	Page:	2 of 3	Document #:	540018000	Rev:

Parts & Accessories Diagram

Model HMD900

PROPRIETARY RIGHTS NOTICE This document and all information contained within it is the property of Hamilton Beach Brands, Inc. (HBB). It is confidential and proprietary and has been provided to you for a limited purpose. It must be returned or destroyed upon request. Disclosure, reproduction or use of this document and any information contained within it, in full or in part, for any purpose is forbidden without the prior written consent of HBB. No photographs may be taken of any article fabricated or assembled from this document without the prior written consent of HBB.

Accessories:

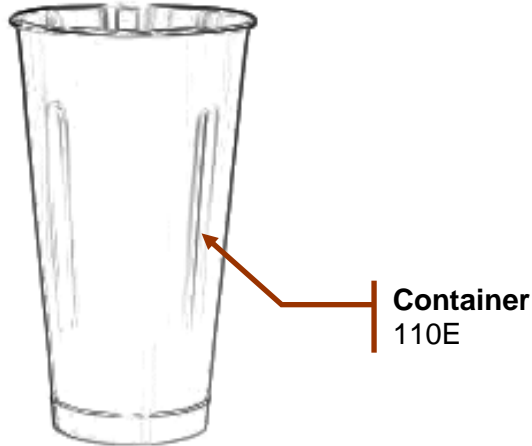

Agitator
929

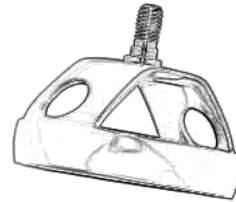

Agitator
930

 4421 Waterfront Drive Glen Allen, VA 23060	Revision Description:		Production Release						
	Request Number:		DOC3111	Revision Date:		10/9/13	Approved by:		DOC3111
	Issue Code(s):		CS, SP	Page:	3 of 3	Document #:	540018000	Rev:	A